

# G30/40/60 1F

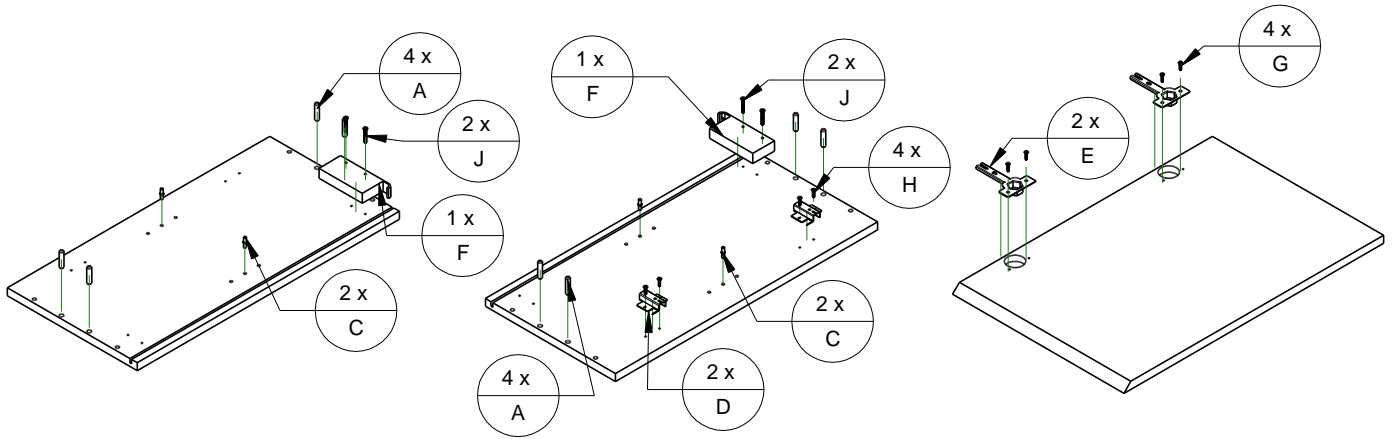

A		x8	B		x8	C		x4
D		x2	E		x2	F		x2
G		$\varnothing 3,5$ 16 x4	H		$\varnothing 4$ 16 x4	J		$\varnothing 4$ 30 x4

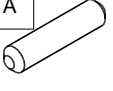
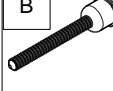
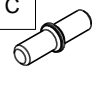
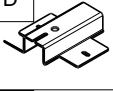
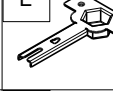
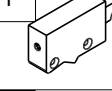
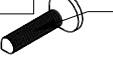
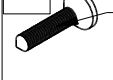
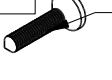